

Drilling Instructions

Instrucciones para taladrar

Instructions de perçage

60729 / 01 Knob / Lever

Tools Needed • Herramientas necesarias • Outils nécessaires

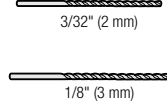
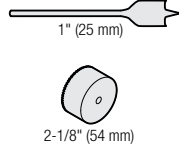
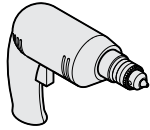

1

Use template to mark holes on door

Utilice la plantilla para marcar los orificios en la puerta
Utiliser le gabarit pour marquer les trous sur la porte

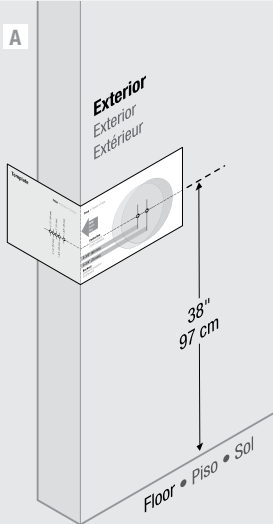

Select the template that allows you to place the template on the EXTERIOR side of door. Fold template along fold line and place fold line along the edge of door. Place centerline approximately 38" (97 cm) from the floor.

Seleccione la plantilla que le permita colocarla del lado EXTERIOR de la puerta. Doble la plantilla a lo largo del doblez y coloque el doblez a lo largo del borde de la puerta. Colocar la línea central a unas 97 cm (38") del suelo.

Choisir le gabarit pouvant être placé sur le côté extérieur de la porte. Plier le gabarit le long de la ligne de pliage et placer la ligne de pliage le long du bord de la porte. Placer l'axe à environ 97 cm (38") du sol.

2

Drill holes in door

Perfore los orificios en la puerta
Perçer les trous de la porte

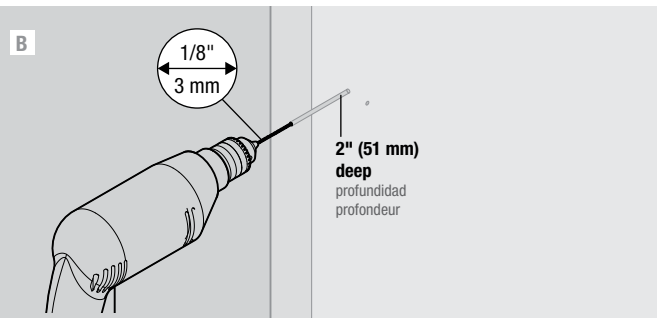
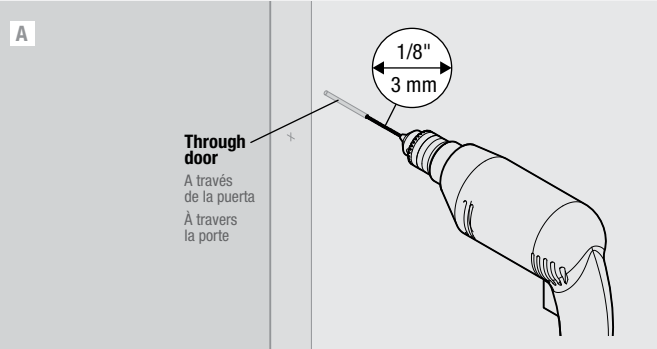

B

Mark hole on the face of the door. Select desired backset before marking hole. If there is another hole in the door, or if you are drilling double doors, make sure to keep the backset consistent.

Marque el orificio en el frente de la puerta. Seleccione la distancia al centro deseada antes de marcar el orificio. Si existe otro orificio en la puerta, o si está perforando puertas dobles, asegúrese de mantener consistente la distancia del frente a la bocallave.

Marquez le trou sur la face de la porte. Sélectionnez l'écartement désirée avant de marquer le trou. S'il y a un autre trou dans la porte, ou si vous percez une porte double, assurez-vous de maintenir la même distance d'entrée.

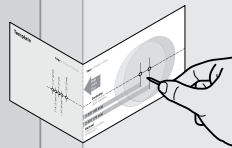

C

Drill from one side until the point of drill just breaks through, then complete hole from the other side to prevent splintering.

Taladre por un lado hasta que la punta de la broca salga al otro lado, luego complete el orificio del otro lado para prevenir astillas.

Perçer à partir d'un côté jusqu'à ce que les dents de la scie apparaissent de l'autre côté, puis finir à partir de l'autre côté afin d'éviter de produire les éclats de bois.

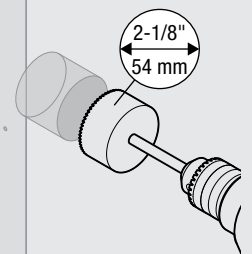

C

Mark hole on the edge of the door. Select door thickness before marking hole.

Marque el orificio en el borde de la puerta. Seleccione grosor de la puerta antes de marcar el orificio.

Marquez le trou sur le bord de la porte. Sélectionnez l'épaisseur de la porte avant de marquer le trou.

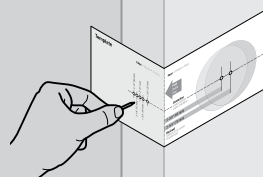

D

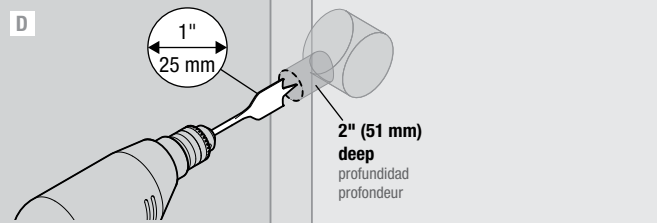

60729 / 01 Knob / Lever

3

Determine which latch will be installed and prepare door edge

Determine qué pestillo se instalará y prepare el borde de la puerta

Déterminez quel verrou doit être installé et préparez le côté de la porte

Latch with rectangular faceplate

Pestillo con placa frontal rectangular
Verrou avec plaquette rectangulaire

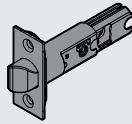

Latch with drive-in collar

Pestillo con aro de empuje
Verrou avec collier de guidage

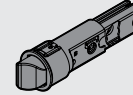

A

If latch is not pre-assembled with desired faceplate, assemble it as shown.

If desired faceplate is not supplied with the latch, please contact Consumer Support.

Si el pestillo no está pre-ensamblado con la placa frontal deseada, ensámblelo de la manera exhibida.

Si la placa frontal deseada no se suministra con el pestillo, contáctese con el Centro de servicio al consumidor.

Si le verrou n'est pas préassemblé avec la plaquette souhaitée, assemblez-le comme indiqué.

Si la plaquette désirée n'est pas fournie avec le verrou, veuillez contacter le service client.

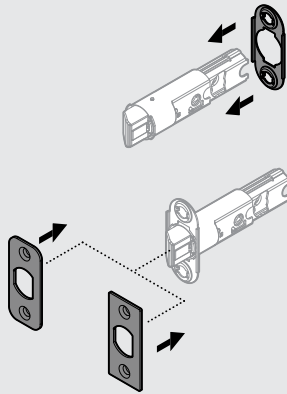

Proceed to Step 4.

Vaya al paso 4.
Passez à l'étape 4.

B

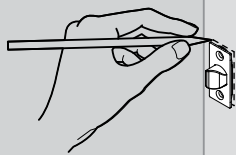

C

Chisel
Cincelar
Ciseler



D

Mark holes
Marque los orificios
Marquer les trous



E

1/8"
3 mm

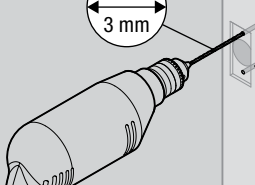

1"
25 mm
deep
profundidad
profondeur

60729 / 01 Knob / Lever

4

Prepare door frame for strike

Prepare el marco de la puerta para la placa
Préparez le cadre de porte pour la gâche

A **Locate center of strike hole:**
Marque el centro del orificio de la placa :
Trouver le centre du trou de la gâche :

Draw level line from center of bore hole across frame.
Marque la línea de nivel desde el centro del orificio de perforación a través del marco.
Tracer la ligne de repère à partir du centre du trou percé à travers le cadre.

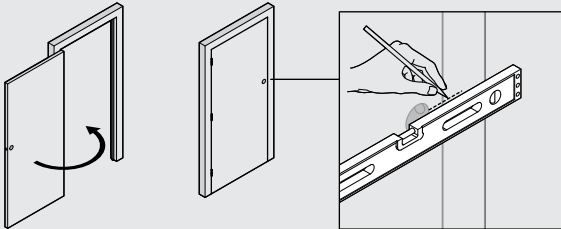

Measure back from door stop, 1/2 thickness of door.
Mida hacia atrás desde el tope de la puerta, hasta la mitad del espesor de la puerta.
Mesurez à partir de l'arrêt de porte à la moitié de l'épaisseur de la porte.

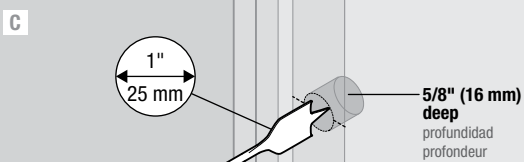
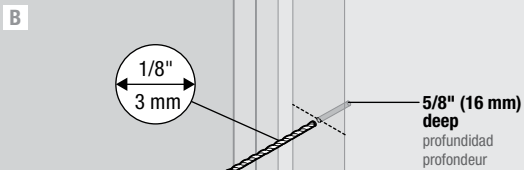
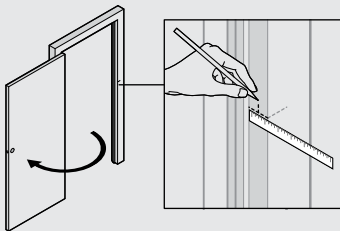

D **Keep level and trace.**
Manténgala nivelada y calque.
Maintenir en position et tracer.

