

BALDWIN®

5013

ESTATE KNOB

SPECIFICATIONS

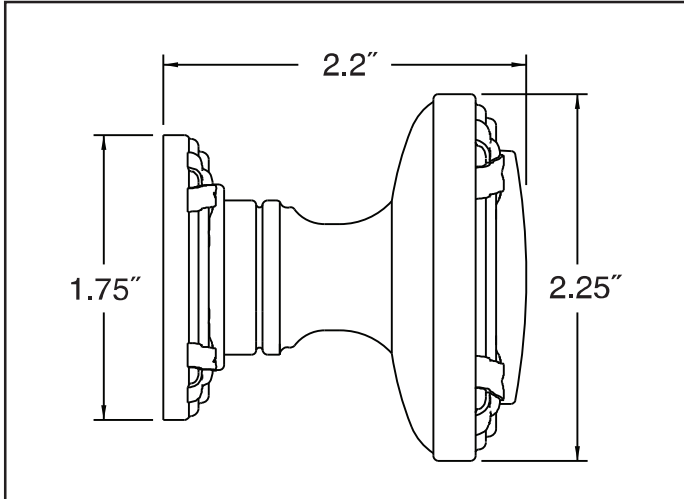

- > Certified by Underwriters Laboratories (UL) for use on fire doors up to three-hour rating
- > U L10C / UBC 7-2 (1997) Positive Pressure Rated, UL10B Pressure Rated
- > Material: Solid Brass

SHOWN WITH ROSE 5016



TIER 1 FINISHES

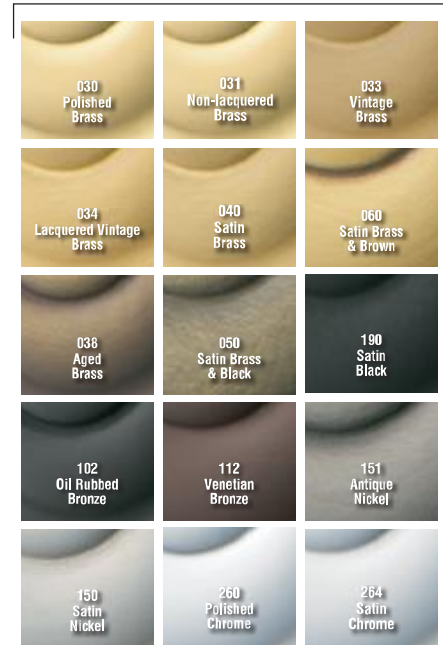

TIER 2 FINISHES

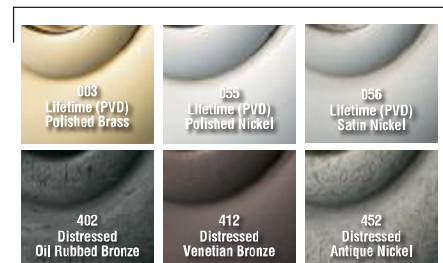

19701 Da Vinci · Lake Forest · California · 92610 · CUSTOMER SERVICE: 800.437.7448 · 8AM - 5PM EST · FAX: 800.255.9785

www.baldwinhardware.com